

MiTek[®]

Posi-Joist Installation Guide



**A GUIDE FOR
STORAGE, HANDLING AND INSTALLATION
OF THE MITEK POSI-JOIST FLOOR SYSTEM**



MASONRY WALL CONNECTION DETAILS

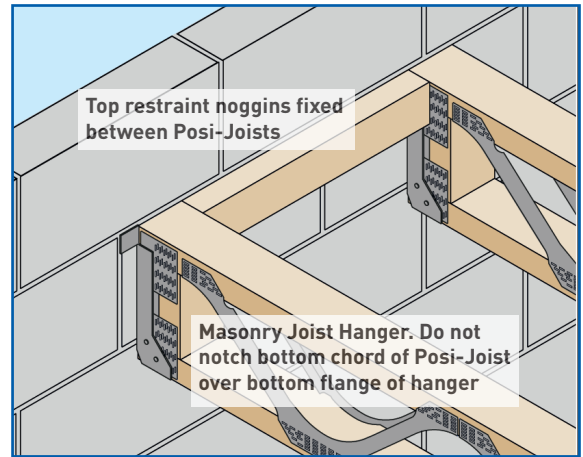
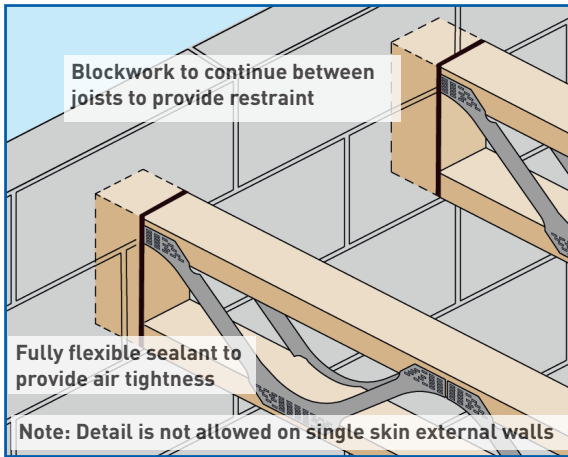

SOIL PIPE CORNER DETAILS

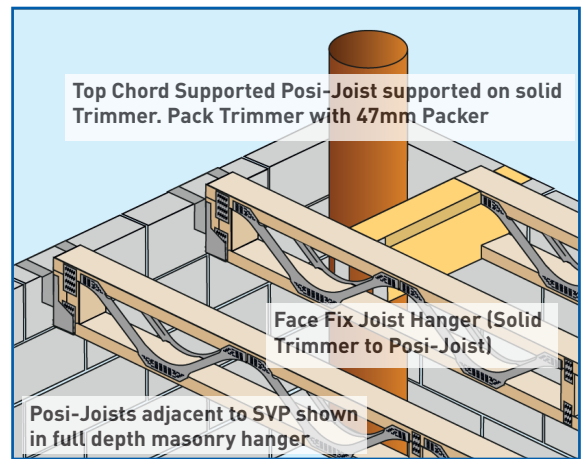
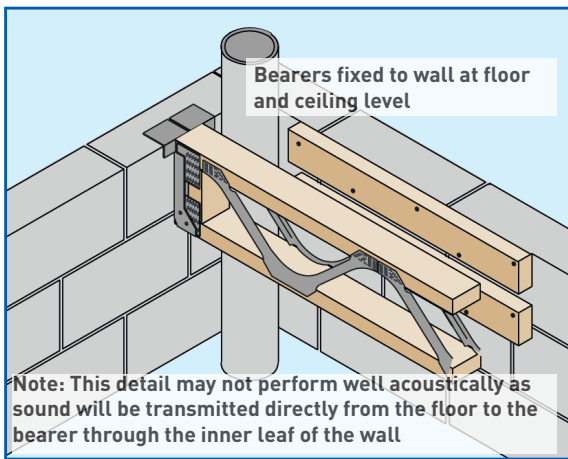

INTERNAL BEARING DETAILS

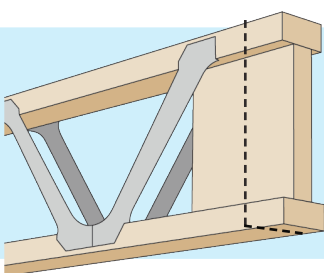
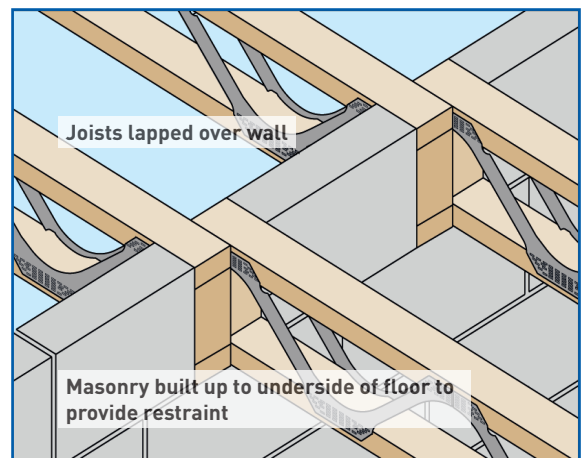
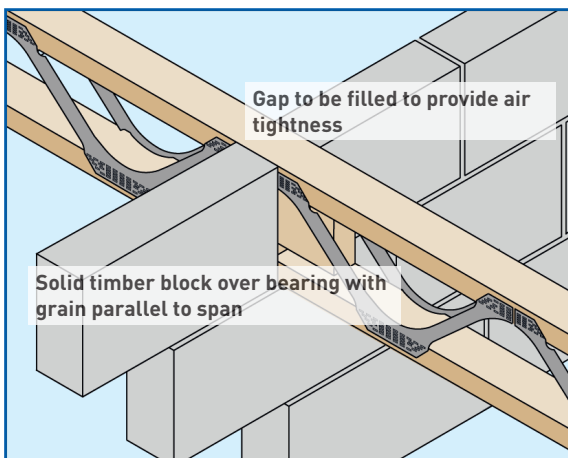

Trimmable End - There when you need it!

The Trimmable End detail allows for tolerance on site where required, allowing for a maximum of 130mm to be trimmed from the ends of the joist. Note that this detail is dependent on the Posi-Joist being manufactured with the end detail shown. If in any doubt please check with Posi-Joist manufacturer before trimming.

OPENING FRAMING DETAILS

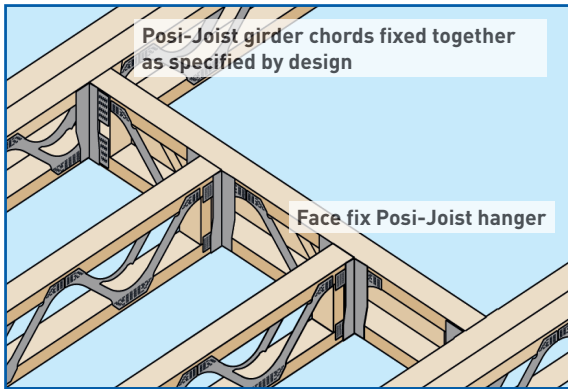

Do not notch Posi-Joist bottom chord over flange of hanger

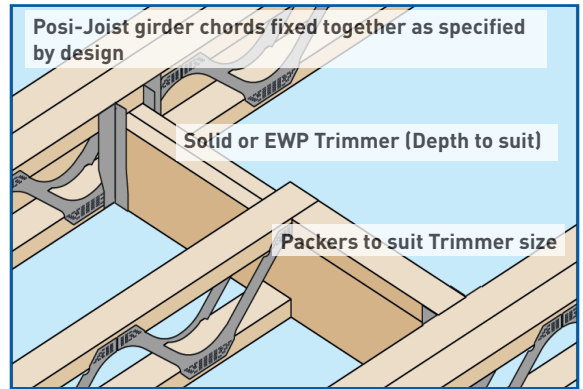

Unless proven by design the Posi-Strut web should overhang the bearing by 15mm

STRONGBACK BRACING DETAILS

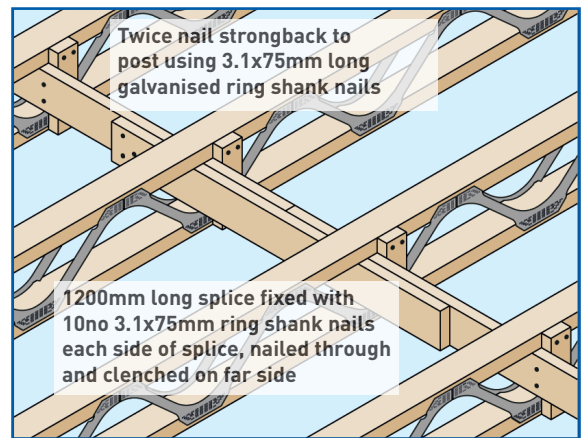
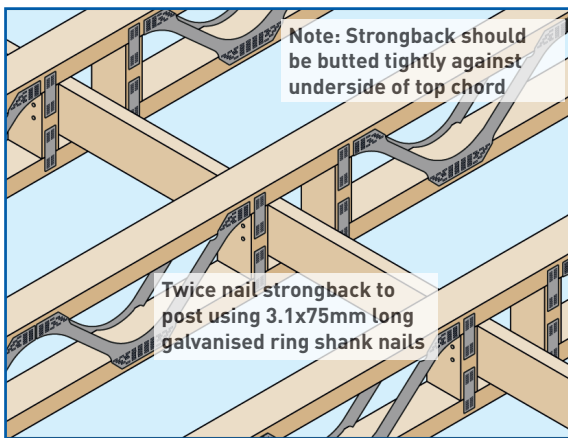

RESTRAINT STRAP DETAILS

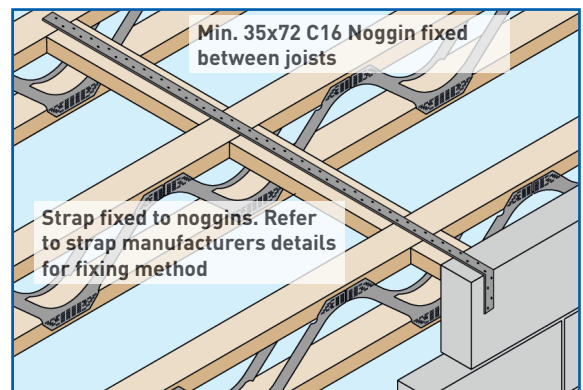
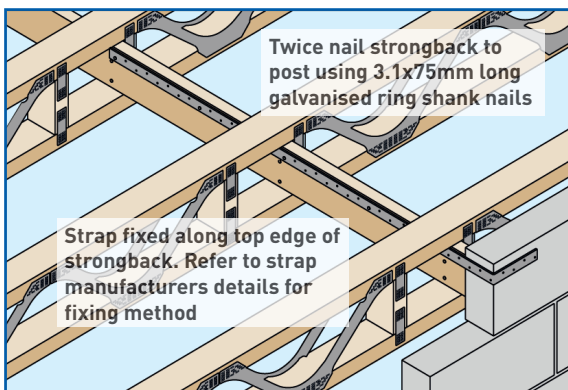

Posi-Joist can be specified in a wide range of depths and specifications:

Web Type	Clearance between flanges	Standard Depth
PS8	108mm	202mm
PS9	131mm	225mm
PS10	159mm	253mm

Web Type	Clearance between flanges	Standard Depth
PS12	210mm	304mm
PS14	279mm	373mm
PS16	327mm	421mm

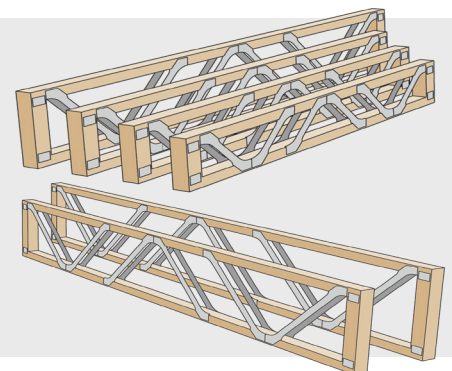

TIMBER FRAME DETAILS

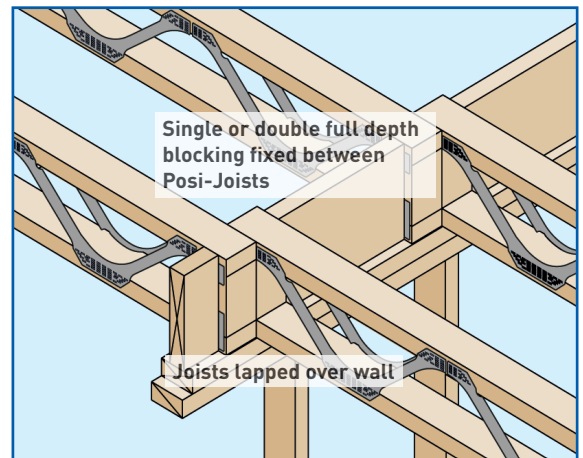
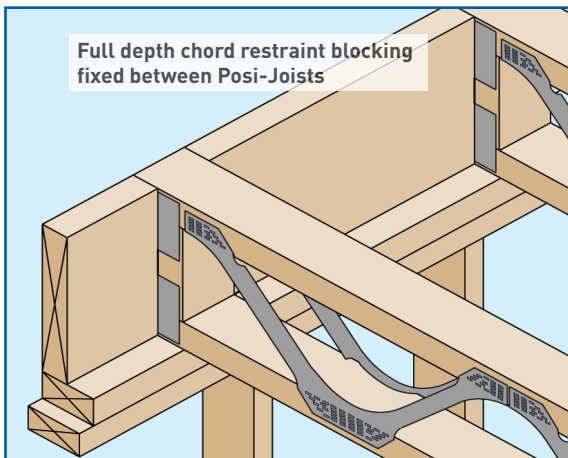
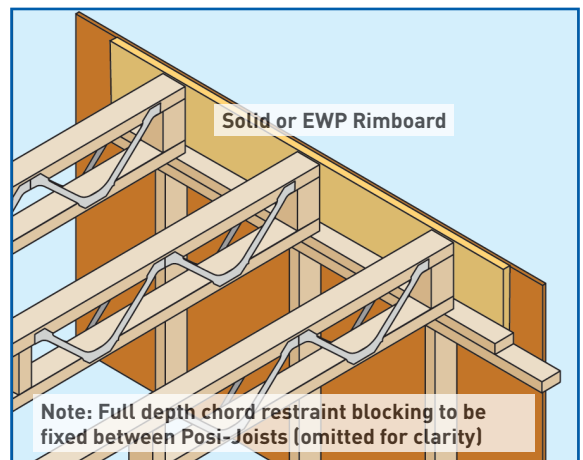
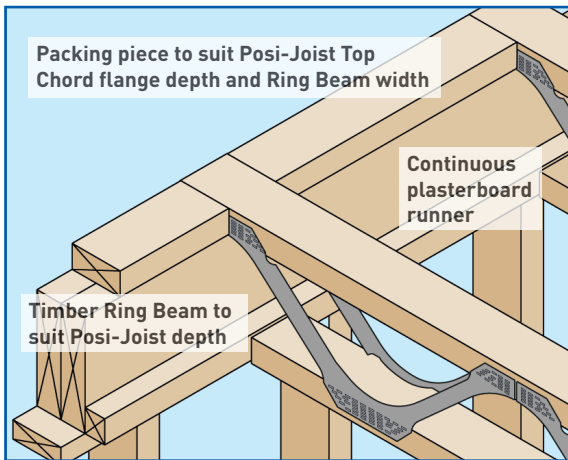
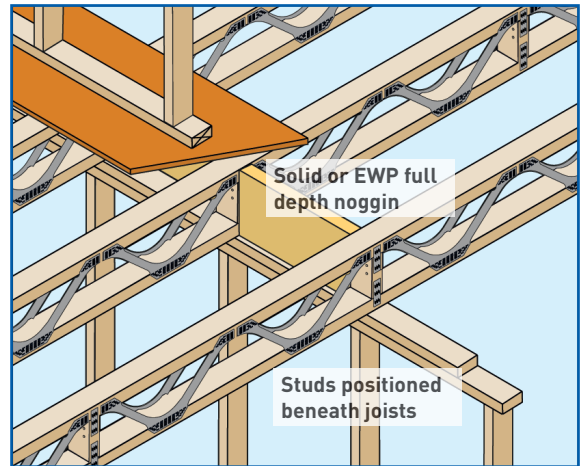
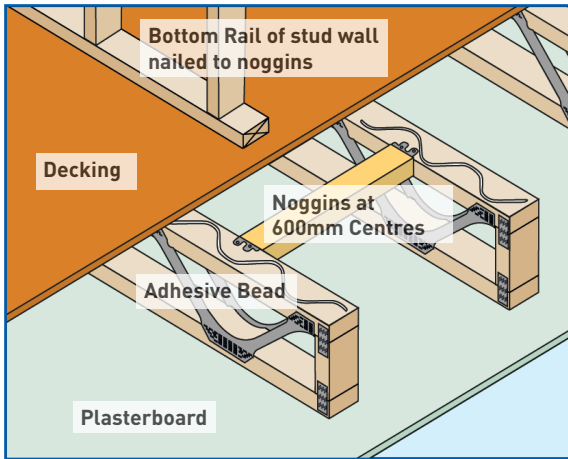

Timber Frame Separating Floor Robust Detail E-FT-3

The E-FT-3 detail comprises of ceiling treatment CT2 made up of two layers of 15mm (nominal 12.5 kg/m²) fireline plasterboard fixed with 25mm and 42mm screws to resilient bars at 400mm centres. On top of an 18mm wood based T&G flooring board, a resilient composite deep batten system with a minimum depth of 70mm is placed with 25mm (10-33kg/m²) insulation placed between the battens. On these battens a 19mm Gypsum based board (nominal 13.5kg/m²) is placed with a final deck of 18mm (min) T&G flooring board on top.

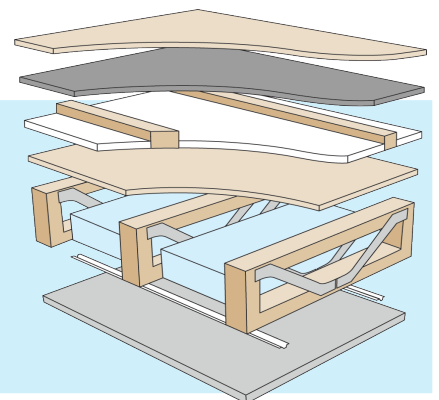

Site Handling and Storage

Storage on site should be for a limited period of time prior to erection of the Posi-Joists.

Posi-Joists should either be stored vertically or on the flat. If stored vertically there should be intermediate bearers at node points not within the bay of a joist, as shown below right. If stored in a flat position, sufficient bearings should be provided to prevent excessive lateral bending.

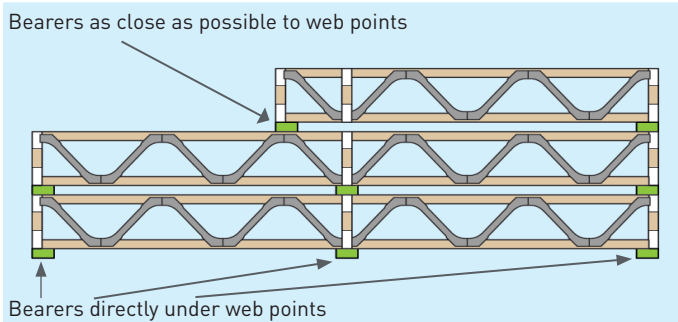

It is recommended that completed Posi-Joists be strapped together and wrapped in a waterproof protective covering to protect them from short term exposure to inclement weather.

Special precautions should be taken when stacking top chord supported floor cassettes to prevent the stack lozenging in storage. Additional bracing to the ends of the stack should be fixed to stop lateral movement. Care should be taken when handling the Posi-Joists to avoid bending, twisting or dropping.

When loading/offloading with a crane, slings should always be attached to the timber chords or the cassette lifting points, and not to the metal webs to avoid buckling. Slings should be attached at panel points closest to the quarter points of the Posi-Joists as shown below.

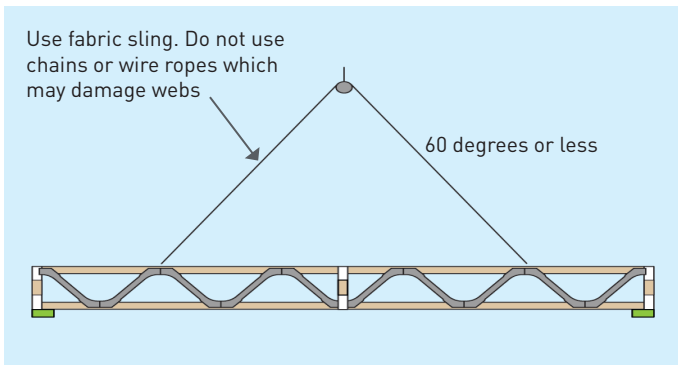

Set Out and Placement

Posi-Joists are generally placed perpendicular to the load bearing supporting walls and should be located so that the distance between them does not exceed the design spacing – always consult the Posi-Joist layout drawing and proceed with erection of the floors as follows:

- 1 Plan the erection sequence and place the Posi-Joists close to where they are required, only distribute a sufficient number of joists around the building which can be erected in a reasonable period of time. Posi-Joists should be protected from inclement weather and stored as noted above.
- 2 Before lifting the Posi-Joists to scaffold level do make sure the correct end of the joist is at the appropriate support as the end details may be different. Also be aware of any internal supports which are being used and that the special internal bearing detail for the joist is in the correct position.
- 3 If the Posi-Joists are supported over more than 2 supports make sure all the supports are the same level and when the joists are lifted into place they rest on all of the supports.
- 4 If the Posi-Joists are supported on masonry hangers, make sure they are the ones specified and are firmly anchored in place and that the masonry is cured in line with hanger requirements. Joists should have a full bearing with no more than a 5mm gap between the end of the joist and the face of the hanger.

- 5 Make sure the Posi-Joists are erected the correct way around, the joists will normally be marked "TOP" and the first metal web will normally start at the top of the Posi-Joists.
- 6 The Posi-Joists are positioned to coincide with the deck joints, the first of which is normally 1210mm away from the wall face in masonry construction or 1200mm from the cavity face in Timber Frame construction when the deck extends to the cavity face; when the joists are spaced at 400 or 600mm centres. There is normally a 10mm perimeter gap between the face of the deck and the face of the wall in masonry construction to allow for potential expansion of the deck. The board material is normally 1200 x 2400mm, the long dimension spanning at 90° to the joist span. The remaining joists are normally spaced on a grid of 400, or 600mm centres, on occasion at 480mm centres.
- 7 When the deck is set out from the face of the wall it is normal to have the first joist edge 50mm from the face of the wall where in Timber Frame construction with the deck set out from the cavity face it is normal to not have a joist close to a wall, the deck and plasterboard being supported on a timber ledger nailed to the frame. Carefully follow the layout drawing and the wall/joist interface details provided by the Building Designer, in particular in Timber Frame where the joist centres and the stud centres may have to line through.
- 8 The penultimate Posi-Joist in the run is set out on the standard module and the last joist is positioned similar to the first in the run.
- 9 Posi-Joist stair trimmer joists and trimmers will be required around stair openings which may be on the main joist grid or usually off the grid. Set these joists out strictly in accordance with the architectural and Posi-Joist layout drawing and fix the trimmer joist to the stair trimmer and the trimmed joists to the trimmer joist with the metal hangers specified making sure that any 2 ply joists are adequately connected together as detailed.
- 10 To temporary brace and space the Posi-Joists which have been laid in position fix a piece of 22 x 97 bracing to the top of the joists at their ends and mid span or around 2.4m centres on spans longer than 4.8m.
- 11 Install the strongback bracing as detailed, the strongback is always installed on edge not on flat and must be fixed to the integral strongback blocks or noggin pieces nailed to the face of the joist. The strongback must be fixed tight to the underside of the top chord. On all top supported Posi-Joist floors with installed strongbacks it will not normally be necessary to use any temporary diagonal bracing. On bottom supported wide flange chords (72mm or wider) once the strongback and rim boards are fixed in place no temporary diagonal bracing is normally required. On bottom supported narrow chords (35 - 47mm) then temporary diagonal bracing is required as well as the strongback and rimboard bracing.
- 12 When all the Posi-Joists have been positioned and fixed in place, the partition noggins, perimeter noggins, rim boards, when required can be installed, and in the case of masonry construction the steel lateral restraint straps should be fixed in place at no greater than 2m centres and should extend over 3 joists.
- 13 The floor carcass is now ready to receive the decking material and acoustic material where required.
- 14 The maximum load of sheet materials temporary stored on the Posi-Joists is 250kg/m² and should not be greater than 300mm deep. This equates to 16 sheets of 18mm chipboard, 13 sheets of 22mm chipboard or 20 sheets of 15mm plasterboard. Where the sheets are stacked by hand they should span lengthways across the joists, (Fig 1), when lifted mechanically they should be seated on 5 bearers the width of which are 600mm longer than the width of the board. (Figs 2 & 3).

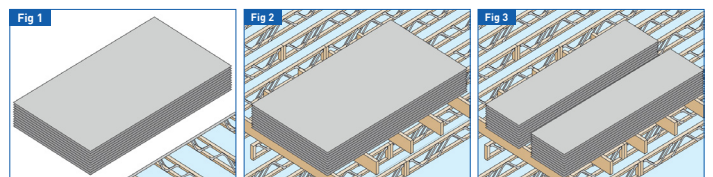

Temporary Erection Bracing Notes

The builder is responsible for identifying and minimising the risks involved in erecting Posi-Joists to ensure that the health and safety of all workers is maintained. Builders should be aware of the health and safety responsibilities imposed on them by the Construction (Design and Management) Regulations 1994. Proper erection procedures and bracing are vital to the safe construction of Posi-Joist floors. The following notes may assist builders in preparing a safety assessment.

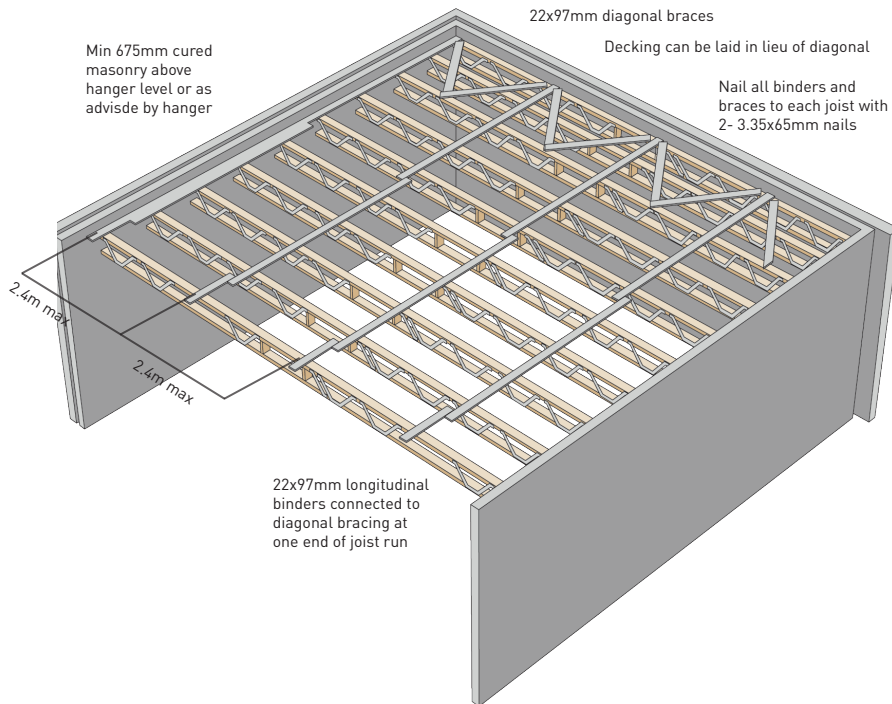

- 1 Un-braced Posi-Joists may be unstable.
- 2 Do not allow anyone to walk on un-braced Posi-Joists.
- 3 Do not store building materials on un-braced Posi-Joists.
- 4 Posi-Joists should be erected straight and vertical. The maximum deviation from horizontal should not exceed 10mm and the maximum deviation from vertical should not exceed 2mm.
- 5 Temporary bracing comprises diagonal bracing, longitudinal binders and permanent strong-backs.
- 6 All longitudinal binders, diagonal braces, strong-backs and hangers should be completely installed and fully nailed as detailed.
- 7 Lateral strength should be provided by a diagonally braced system across at least 3 Posi-Joists as shown in the Erection Bracing diagram. Additional braced and blocked systems should be added at 12m spacing in long joist runs.
- 8 Temporary bracing may be progressively removed as decking is fixed.

Dos and Don'ts

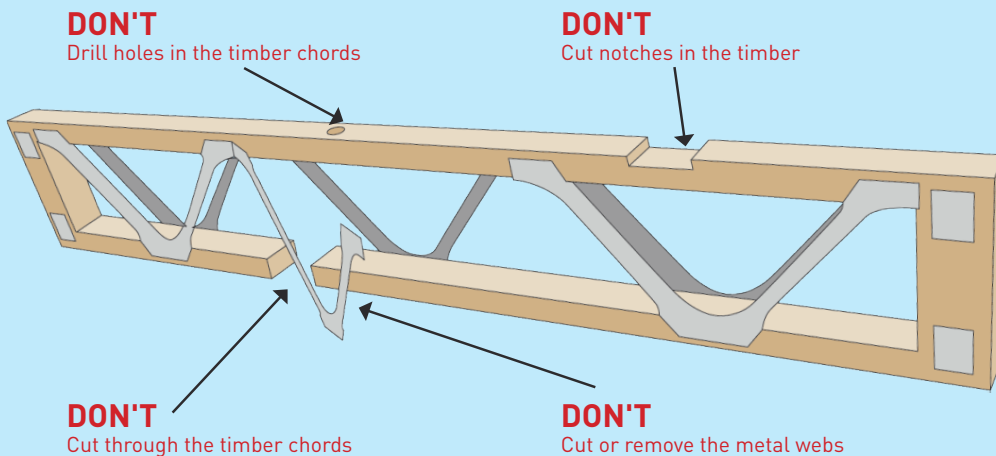

DOWNLOAD THE POSI TECHNICAL HANDBOOK

Including full fire and acoustic performance information, construction details and much more.

To download and for more information visit www.posi-joist.co.uk



Authorised Posi-Joist Manufacturer

MiTek®

MiTek Industries Ltd
MiTek House, Grazebrook Industrial Park,
Peartree Lane, Dudley, DY2 0XW

Tel: +44 (0) 1384 451400
Email: info@mittek.co.uk

